

## CONTENTS



















Warwick Rubberbands	114
Warwick Hook & Loop	115
Adhesives	116
Pins and Clips	118
Scissors	120
Cutters	120
Staplers and Staples	121
Punches	122
Trimmers	124
Sundry Accessories	124
Conference and Security	126
Stamps	126



Cross cut shredders require occasional oiling of the cutters. A good way to remember is to oil them when you empty the bin.

# WARWICK RUBBERBANDS

Premium quality rubber bands available in five band widths and four different box sizes: 30g, 60g, 115g, 500g. 2kg bags also available. Can be purchased in bulk – 10kg packs available on request.

Size	60g	115g	500g	2kg	
No. 8	300051	300091	300146	300249	1.6 x 22mm 
No. 10	300053	300093	300151	300251	1.6 x 32mm 
No. 12	300055	300095	300157	300253	1.6 x 41mm 
No. 14	300057	300097	300163	300254	1.6 x 51mm 
No. 16	300059	300099	300169	300255	1.6 x 64mm 
No. 18	300061	300103	300175	300256	1.6 x 76mm 
No. 19	300063	300107	300181	300257	1.6 x 89mm 
No. 30	300065	300111	300187	300258	3.2 x 51mm 
No. 31	300067	300115	300190	n/a	3.2 x 64mm 
No. 32	300069	300119	300192	300260	3.2 x 76mm 
No. 33	300071	300123	300195	300261	3.2 x 89mm 
No. 34	300073	300127	300198	300262	3.2 x 102mm 
No. 62	n/a	n/a	300203	n/a	6.4 x 64mm 
No. 64	300079	300133	300213	300265	6.4 x 89mm 
No. 65	n/a	n/a	300219	300263	6.4 x 102mm 
No. 73	n/a	n/a	300223	300264	9.5 x 76mm 
No. 77	n/a	n/a	n/a	300266	9.5 x 127mm 
No. 105	n/a	n/a	n/a	300267	15.9 x 127mm 
Assorted	300276	300278	300280		

**300275** Assorted 30g

**Warwick Rubber Band Ball**  
Premium quality coloured rubber bands supplied in a handy ball for ease of use and storage.  
**300156** 200gm Assorted Colours



## WARWICK HOOK & LOOP

**WARWICK**<sup>NZ</sup>

### HOOK & LOOP FASTENER

Designed for making things stick...until you change your mind. Ideal for displaying or fastening all sorts of things around the place. It's easy to get to grips with, don't panic if you get stuck, you've probably done it right!

*It's as easy as Peel, Stick & Grip*

**SPOT  
THE  
'DO'S'  
AND  
DON'TS**



Ideal for using to keep your rug in place



Less ideal for using to keep this rug in place

### WARWICK HOOK & LOOP FASTENERS – HANDY

**383089** Hook & Loop Spots 22mm White Pack 12

**383090** Hook & Loop Spots 22mm Black Pack 12

**383091** Hook & Loop Strip 20mm White 150mm

**383092** Hook & Loop Strip 20mm Black 150mm



### WARWICK HOOK & LOOP FASTENERS – STANDARD

**383081** Hook & Loop Spots 22mm White Pack 62

**383082** Hook Only Spots 22mm White Pack 125

**383083** Hook & Loop Strip 20mm White 1.8m

**383084** Hook Only Strip 25mm White 3.6m



### WARWICK HOOK & LOOP FASTENERS – BULK

**383086** Hook & Loop Spots 22mm White Pack 225

**383087** Hook Only Spots 22mm White Pack 450

**383088** Loop Only Spots 22mm White Pack 450

**383085** Hook & Loop Strip 20mm White 5m



## ADHESIVES



# Blu-Tack

The original re-usable adhesive



**Sticks,  
Seals,  
Holds,  
Positions**



For other Blu Tack uses check out  
[www.blutack.com](http://www.blutack.com)

**Bostik**

## BOSTIK BLU-TACK

The most famous Bostik product on the market – Bostik Blu-Tack and Blu-Tack Colour. Versatile option for sticking posters, pictures, charts and maps to your wall. Won't leave a hole in your wall! Reusable – just roll off the surface and recycle.

309002 Blu-Tack

309028 Blu-Tack Colour



## BOSTIK BLU STIKS

These high quality Bostik BluStiks are non-toxic and acid free. Glue goes on blue then dries completely clear!

309046 8gm

309047 21gm

309048 35gm



## BOSTIK GLUE STICKS

Bostik adhesive products include the white glue sticks in 21gm and 35gm sizes. Will bond paper, card and fabric. Non-toxic and washable.

309035 21gm

309040 35gm



## BOSTIK ADHESIVES

Available in gums, pastes, PVAs and even super glues. An adhesive product to suit every requirement.

309025 Clearbond Glue 50ml

309060 Handyman Super Glue 3ml Hangsell



309025



309060

## AMOS GLUE STICKS

The distinctive green and gold packaging of the Amos Glue Stick makes it instantly recognisable as one of New Zealand's top selling glue sticks. The non-toxic, acid free adhesive formula is great for paper, photos and cardboard gluing. Available in small, large, jumbo, and hangsell multi-packs.

- 200002 Small 8gm
- 200001 Large 15gm
- 200000 Jumbo 35gm
- Multi Packs**
- 200003 35g + 8g Hangsell
- 200004 2 x 8g Hangsell
- 200005 5 x 8gm Hangsell



## SELLOTAPE TAPE

Made from biodegradable, clear, cellulose film, original cellulose tape is strong, yet still tears easily by hand when required.

- 303172 18mm x 33m
- 303178 Economy 12mm x 66m
- 303174 Economy 18mm x 66m
- 303182 15mm x 66m
- 303184 18mm x 66m
- 303094 4 Roll Pack 15mm x 10m
- 303198 Invisible 18mm x 33m



303198

## SELLOTAPE DOUBLE-SIDED TAPE

Made from tough, vinyl film and coated on both sides with a strong, permanent adhesive.

- 303188 12mm x 33m
- 303190 18mm x 33m
- 303192 24mm x 33m



## SELLOTAPE PACKAGING TAPE

Premium quality. Available in clear and brown.

- 303252 Clear 36mm x 55m
- 303254 Clear 48mm x 55m
- 303260 Brown 1554 55m x 36mm
- 303262 Brown 1554 55m x 48mm



## 3M SCOTCH MAGIC TAPE

Quality tape with matt finish that disappears when applied.

- 302048 19mm x 33m



## SELLOTAPE HANGSELL RANGE

- 303150 Clear Tape Refill 15mm x 10m
- 303152 Clear Tape Twin Pack 15mm x 10m
- 303156 Clear Tape Refill 15mm x 33m
- 303158 Clear Tape Dispenser Black 18mm x 33m
- 303136 Double-sided Tape 12mm x 15m
- 303195 Invisible Tape Twin Pack 15mm x 10m
- 303162 Masking Tape 24mm x 20m
- 303146 Packaging Tape 36mm x 30m



303156

303195

303146

303136

303162

303150

## PINS AND CLIPS

### DIXON HANGSELL RANGE

A range of top quality Dixon fasteners, available in convenient hangsell packaging. Designed for those looking to buy these products in small quantities, they are great for the small or home office. The smart packaging creates an eye-catching in-store display, making it a perfect product for stationery retailers.

- 290050 Foldback Clips 15mm 8 Pieces
- 290051 Foldback Clips 19mm 6 Pieces
- 290052 Foldback Clips 25mm 5 Pieces
- 290053 Foldback Clips 32mm 4 Pieces
- 290054 Foldback Clips 51mm 1 Piece
- 290055 Foldback Clips Assorted Colours 25mm 5 Pieces
- 290060 Letter Clips 23mm 10 Pieces
- 290062 Letter Clips 40mm 5 Pieces
- 290063 Letter Clips 50mm 4 Pieces
- 290075 Brass Drawing Pins 11mm 75 Pieces
- 290076 Coloured Drawing Pins 9.5mm 50 Pieces
- 290077 Coloured Push Pins 30 Pieces
- 290080 Book Rings 26mm 5 Pieces
- 290081 Book Rings 38mm 4 Pieces
- 290079 2 Piece Fasteners 50mm 10 Pieces
- 290078 Paper Fasteners 19mm 30 Pieces



290060

290062

290063



290051

290052

290053

290054



290055



290079



290075

290076

290077



290078

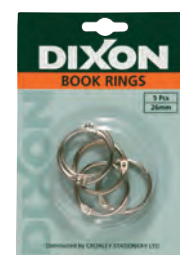

290080



290081

### DIXON PAPER CLIPS

The most popular method of fastening small documents – paper clips are light, durable and of course, economical. Available in round, triangular and coloured packs, paper clips are an essential tool for home, office and school environments.

- 200338 31mm Rainbow Pack 200
- 200339 25mm Tri Pack 200
- 200340 31mm Round Pack 200
- 200336 31mm Tri Pack 200
- 200338 31mm Rainbow Pack 200
- 300102 50mm Non-slip Pack 100
- 200335 75mm Pack 20
- 200337 95mm Pack 20
- Magnetic Paper Clip Dispenser**
- 200435 Magnetic Round Large



200336

### DIXON PUSH PINS AND DRAWING PINS

**Push Pins** Versatile pins with a large plastic head. Available in convenient packs of 100, in a cheerful multi-colour assortment.

- 290029 Box 100

**Drawing Pins**

- 201701 Brass No. 3 Packet 100



290029

## DIXON BOOK RINGS

Bind documents with a single hole. The stiff, chrome plated book rings won't rust or pull apart.

- 200393 26mm
- 200394 38mm
- 200395 50mm
- 200760 75mm



## DIXON LETTER CLIPS

The chrome plated letter clips have a strong spring grip and are designed to secure thick files without damaging the paper. The chrome finish provides a stylish look to the fastening system. Available in five sizes, from 32mm to 76mm, and purchased in individual units.

- 200326 32mm
- 200327 40mm
- 200328 51mm
- 200329 65mm
- 200330 76mm



## DIXON FOLDBACK CLIPS

The foldback clip is dual purpose – the flip handles fold down for convenient flat storage – fold them back and use them to hang your document. Available in a range of sizes from 15mm to 50mm widths – something for all document sizes. Made from tough steel that won't rust. Packed in boxes of 12.

- 201719 15mm
- 201720 19mm
- 201721 25mm
- 201722 32mm
- 201723 41mm
- 201724 50mm



## DIXON TWO PIECE FASTENERS

An economical paper fastener that can bind up to 50mm of paper. Lies flat for convenient document storage.

- 245280 Box 50



## CLIPPIE CLIPS

The unique patented fastening system that clips thick documents with ease. No dispenser is required, and the clips are reusable. The small Clippies hold up to 25 sheets of paper, the large Clippies hold up to 50 sheets of paper, and the extra large Clippies can hold up to 75 sheets of 80gsm paper.

### Standard

- 201300 Small Box 100
- 201301 Small Pack 15
- 201305 Large Box 50
- 201306 Large Pack 15
- 201303 Extra Large Box 30

### Coloured

- 201310 Small Box 100
- 201312 Small Pack 15
- 201311 Large Box 50
- 201313 Large Pack 15



## OPEN MAP PINS AND PUSH PINS

Ideal for pinning maps, charts, planners and posters. Open map pins have a plastic rounded head and a super sharp point. Available in single colours or packs of assorted colours. Open push pins are versatile pins with a large plastic head. Also available in single colours and assorted packs.

### Map Pins

- 268949** Assorted Colours Box 100
- 268935** Black Box 100
- 268943** Blue Box 100
- 268936** Red Box 100
- 268941** White Box 100

### Push Pins

- 268940** Single Colours Box 15
- 268929** Assorted Colours Box 50



## ZIP CLIPS

The Zip Clip is a convenient alternative to traditional staples. Strong and efficient, Zip Clips hold up to 5mm of paper. Zip Clips are used with the unique dispensing gun and can be recycled for use over and over.

The system is easy to use, remove and reuse.

**200344** Refills Pack 50 (Chip Clip)

**200346** Dispenser (Chip Clip)



## SCISSORS

### WARWICK SCISSORS HANGSELL

**117141** Graduated 5" 135mm

**117142** General 8" 210mm



## CUTTERS

### OLFA CUTTERS

A range of premium quality knives and cutters for use in the warehouse, home and school. The range includes art knives, touch knives and heavy duty cutters.

**269100** Cutter L5 Heavy Duty Comfort Grip 18mm

**269101** Cutter L5-AL Heavy Duty Comfort Grip 18mm

**269114** Cutter XA-1 Comfort Grip

**269119** Cutter XH-1 Extra Heavy Duty Comfort Grip 25mm

**269166** Cutter Safety SK-7

**269167** Cutter Safety SK-8

**269110** Art Knife AK-1

**269139** Mini-touch Knife Auto Retractable TK-4 Multi-load Auto-lock 9mm

**269112** Art Knife One-way Lock 9mm Plus 5 Free Blades



269139

269100

269119

269101

269166

269114

269167

269110



## OLFA BLADES

Replacement blades for Olfa knives and cutters. The Excel black blades demonstrate 25% more cutting power than standard Olfa blades.

- 269261 LBB-10B for L5-AL, L5
- 269241 LBB-50 for L5-AL, L5
- 269247 SKB-8/10B for SK-8
- 269246 SKB-7/10B for SK-7
- 269245 SKB-2/5B for SK-4
- 269270 KB for AK-1
- 269290 HB-5B for H1
- 269255 Rotary 45mm for RTY-2/DX
- 269251 ASBB Excel Black for A-2, A-5B, 180



269255

## OLFA ACCESSORIES

The range includes a blade disposal case, multi-purpose scissors and cutting mats.

- 269150 Self-healing Mat 600 x 430mm

269150 - Side 1 centimetres

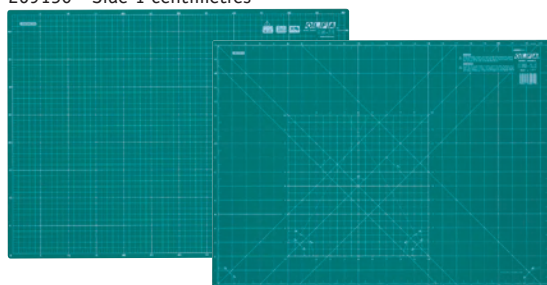

269150 - Side 2 inches

## STAPLERS AND STAPLES

### KW-TRIO DESK STAPLERS – EFFORTLESS

60% less effort with a ergonomic soft grip handle. Push button magazine for simple loading of staples. Full rubber base and tough steel construction. Capacity up to 40 sheets with ease. Staples 24/6, 24/8, 26/6, 26/8. Fits staple length up to 8mm. Assorted.

- 230080 Full Strip
- 230081 Half Strip



### KW-TRIO DESK STAPLERS – NOVA

Stylish and ergonomic design with sturdy die cast construction for durability. Soft-touch top for comfortable operation. Full length non-slip rubber base. Capacity up to 20 sheets of 80gsm paper. Staples 24/6 or 26/6.

- 230008 Nova Full Strip
- 230009 Nova Half Strip



230008

230009

### KW-TRIO DESK STAPLERS – TRIO

Rubber grip with plastic body, quality steel components and non-slip rubber base. Capacity up to 20 sheets of 80gsm paper. Staples 24/6 or 26/6.

- 230014 Trio Full Strip
- 230015 Trio Half Strip

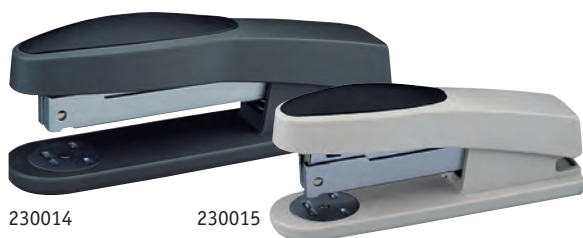

230014

230015

### KW-TRIO DESK STAPLERS – PLASTIC

- 230000 Full Strip
- 230001 Half Strip

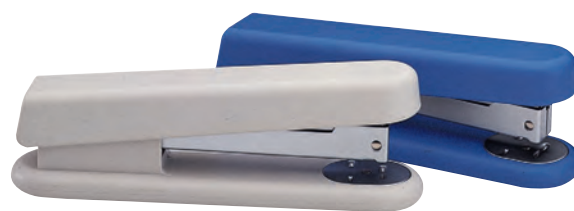

### KW-TRIO DESK STAPLERS – NO. 3 MINI AND NO. 10

**No. 10:** Plastic. Capacity up to 20 sheets of 80gsm paper. No. 10 Staples.

- 230535 Mini Stapler No. 3 with 26/6 Staples Hangsell

- 230011 No. 10

- 230017 No. 10 with Staples Hangsell

230017

230535



230011

### KW-TRIO DESK STAPLERS – STAND-UP

Elegant, stand-up, full strip stapler.

- 230120 Stand-up Black



### STAPLES AND STAPLE REMOVER

- Dixon
- 201210 26/6 Pack 5000
- KW-Trio
- 230018 26/6 Box 5000
- 230019 26/6 Box 1000
- 230020 26/8 Box 1000
- 230021 No. 10 Box 1000
- 230022 23/8 Box 1000
- 230024 23/13 Box 1000
- 230026 23/23 Box 1000
- 230027 24/6 Box 1000
- 230039 Staple Remover



### KW-TRIO STAPLERS HEAVY DUTY AND HAND TACKER

**590 Long Arm Stapler** – the KW 5900 long arm stapler is ideal for stapling large sheets reaching up to a length of 300mm. All metal construction with non-slip base. Adjustable paper stopper for accuracy. Capacity up to 20 sheets of 80gsm paper. Staples 24/6, 26/6.

**Heavy Duty Stapler 100 Sheet Capacity** – versatile heavy duty stapler are perfect for all paper jobs, and ideal for binding reports, booklets or presentations. Tough metal construction. Easy rear loading. Full adjustable paper guide. Throat depth 65mm. Capacity up to 100 sheets of 80gsm paper. Staples 23/6, 23/13.

**Heavy Duty Stapler 210 Sheet Capacity** – for the bigger jobs, this high capacity model is ideal for binding large reports and presentations. Tough metal construction. Easy rear loading. Full adjustable paper guide. Throat depth 70mm. Capacity up to 210 sheets of 80gsm paper. Staples 23/6, 23/23.

- 230005 Stapler Long Arm 317mm Throat 5900
- 230035 Heavy Duty Stapler 100 Sheet Capacity 50SB
- 230036 Heavy Duty Stapler 200 Sheet Capacity 50LB



### PUNCHES

#### KW-TRIO DESK PUNCHES

High quality precision hole punches from KW-Trio. Featuring paper guides and handle locks, with removable chip trays for easy cleaning.

- 230501 2 Hole Mini 10 Sheet
- 230502 2 Hole Medium 20 Sheet
- 230503 2 Hole Heavy Duty 30 Sheet
- 230506 2 Hole Heavy Duty 40 Sheet
- 230500 UFO 40 Sheet Blue



## OPEN DESK PUNCHES

Durable and user-friendly Open hole punches are made to last! They range in capacity from the 11 Sheet PU-5 to the 18 Sheet PU-10, which also comes with a handy paper guide for accurate punching every time. Sheet capacity is based on a very common pad paper weight of 64gsm.

**268408** PU-5 2 Hole 10 Sheet Mini

**268403** PU-10 2 Hole 20 Sheet

**268404** PU-1 1 Hole 15 Sheet



## OPEN OFFICE PROFESSIONAL PUNCHES

The office professional will appreciate these Open products for their reliability and ease of use as medium duty hole punches. Features include movable paper guide for accurate and consistent hole placement.

**268407** PU-20 2 Hole 40 Sheet

**268401** PU-15 2 Hole 30 Sheet

**268405** PU-80 2 Hole 50 Sheet

**268424** PU-303 3 Hole 15 Sheet

**268420** PU-666 3 Hole 40 Sheet



## OPEN HEAVY DUTY PUNCHES AND ADJUSTABLE PUNCHES

Open heavy duty and adjustable punch models can be relied upon to accurately punch all your non-standard documents. Set holes to widths as required, or punch up to 160 sheets of paper. Spare parts available.

**268427** PU-3000 2 Hole 160 Sheet

### Open Adjustable Punches

**268414** PU-838 3 Hole 15 Sheet Adjustable

**268419** PU-848 4 Hole 15 Sheet Adjustable



## KW-TRIO POWER PUNCHES

High quality heavy duty hole punches from KW-Trio. Large capacity punches ranging from 70 sheets through to the powerful 190 sheet punch. Featuring paper guides and handle locks, with removable chip trays for easy cleaning.

- 230508** Heavy Duty 70 Sheet Punch  
**230509** Heavy Duty 100 Sheet Punch  
**230507** Power Punch 190 Sheet



230508



230509

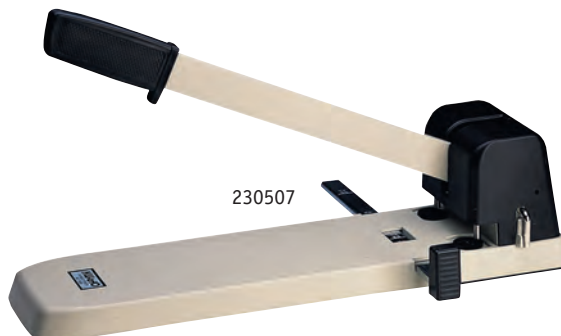

230507

## TRIMMERS

### KW-TRIO TRIMMERS

The latest in precision manufacturing from KW-Trio – a range of durable, economical trimmers with a high level of functionality. The rotary trimmers cut through up to 15 sheets of 80gsm paper and the guillotines have a 10 sheet cutting capacity. Available in both A3 and A4 models.

- 230545** A3 Rotary Trimmer 15 Sheet Capacity 3919  
**230555** A4 Metal Paper Guillotine 10 Sheet Capacity 3922  
**230565** A3 Plastic Paper Guillotine 10 Sheet Capacity 3914

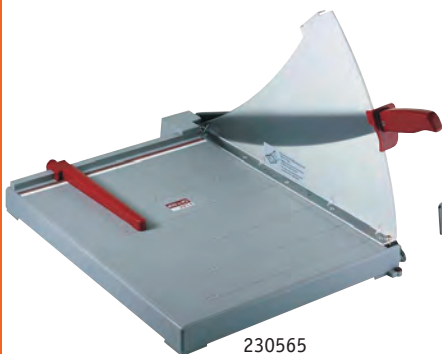

230565



230555



230545

## SUNDRY ACCESSORIES

### DAMPENERS

- 300184** Yellow Compressed Sponge 70mm  
**300186** Sponge Bowl Plastic Assorted Colours  
**300250** Sponge Bowl and Moistener



### WASTE BINS

- Plastic Heavy Duty**  
**300384** Black  
**300386** Grey  
**300388** Beige  
**Fluteline Metal**  
**388001** 30cm Black  
**388003** 30cm Navy



## KW-TRIO SUNDRY

A high quality range of stationery and office equipment for the desktop.

- 230037** Pencil Sharpener Robot 314A
- 230040** Desk Pencil Sharpener
- 230043** Auto Number Machine 6 Wheel 7 Action 2060
- 230053** Auto Number Machine 5 Wheel 7 Action 2050
- 230090** Pads For Auto Number Machine Pack 5
- 230091** Ink Refill For Auto Number Machine
- 230065** Maths Set



230037

230040

230043

230090

230091

230065

## PRIMA LETTER TRAYS

- 300042** Black
- 300043** Green
- 300044** Grey
- 300046** Midnight Blue
- 300047** Monarch Red



## DIXON LISTFINDERS

Easy to use, ideal for storing phone, fax and email information. Essential desktop tool for quick and convenient data retrieval.

### Dixon Telephone ListFinders

- 201204** Index Black



## BUSINESS CARD CASES

### Dixon Acrylic

- 201220** 600 Capacity
- 201221** 400 Capacity

### KW-Trio

- 230041** 440 Capacity

## DIXON RESEALABLE BAGS

- 201251** 65 x 75mm Pack 50
- 201252** 75 x 100mm Pack 50
- 201253** 100 x 155mm Pack 50
- 201254** 130 x 200mm Pack 50
- 201255** 180 x 255mm Pack 25
- 201256** 230 x 305mm Pack 25
- 201258** 330 x 330mm Pack 25

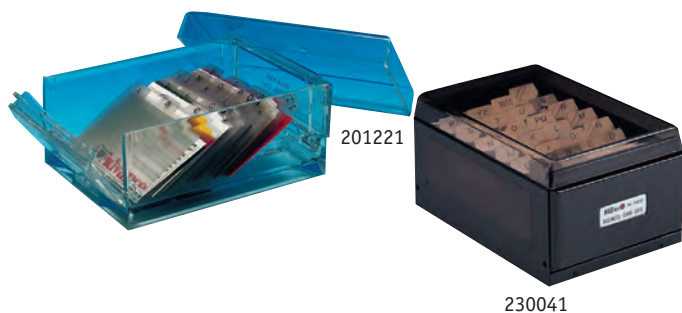

201221

230041



# CONFERENCE AND SECURITY

## DIXON CONFERENCE AND SECURITY ACCESSORIES

An essential range of Dixon branded conference and security accessories, including adjustable safety lanyards in the most popular colours, a selection of ID pouches as well as various key/card holders with different clip and pack options to suit. Safe and user-friendly by design.

### Lanyard Flat Adjustable Breakaway Gator/Strap

- 123000 Black Pack 10
- 123002 Blue Pack 10
- 123004 White Pack 10

### ID Products

- 123010 ID Pouch Soft Landscape Insert  
88 x 63mm Clear Pack 10
- 123012 ID Pouch Soft Portrait Insert  
63 x 88mm Clear Pack 10
- 123030 ID Pin and Clip Gator/Strap Pack 10
- 123060 Key Ring Licence Holder for NZ Licence

### Key/Card Reel Retractable

- 123040 Strap Large Black Single
- 123044 Swivel Large Black Single
- 123050 Strap Small Black Single
- 123054 Swivel Small Black Single

### Name Tag Holders

- 200422 Name Tag Holder Pin and Clip Box 50

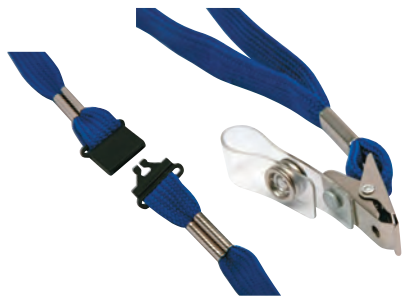

123000 123002 123004



123010 123012 123030



123040 123044 123050 123054



200422

# STAMPS

## DIXON STAMPS

Self-inking stamps in a wide range of titles – over 50 words and icons available. Save time when you need to repeat the same message over and over. Dixon stamps are manufactured from durable plastic and will provide up to 50,000 impressions guaranteed. Titles are available in blue and red. Refill ink is available. Refill the ink by turning stamp upside down and applying a few drops of ink to the stamp face. Leave upside down for five minutes before using.

### Dixon Stamps – Round

- 273202 Bee Red
- 273203 Bee Blue
- 273206 Kiwi
- 273041 Shining Star
- 273200 Smiley Face Large
- 273210 Smiley Face Small
- 273201 Smiley Face

### Dixon Stamp Refill Ink

- 273400 Pre-Ink Refill Blue 15ml
- 273401 Pre-Ink Refill Black 15ml
- 273402 Pre-Ink Refill Red 15ml

### Dixon Stamp Stands

- 273300 Counter Stand Small 36 Stamps Empty

### Dixon Stamp Try-Out Pads

- 440194 Try Out Pad



273206 273201 273200



273300



273402 273400 273401

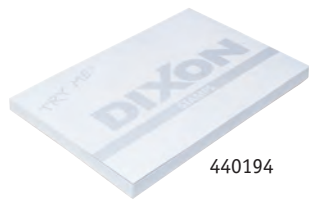

440194

## DIXON STAMP IMPRESSIONS

Standard Titles			
 273038	 273024	 273032	 273018
 273043	 273014	 273005	 273002
 273013	 273012	 273028	 273003
 273065	 273001	 273011	 273047
 273026	 273000	 273027	 273021
 273015	 273034	 273049	 273031
 273044	 273006	 273007	 273010
 273022	 273048	 273059	 273004
 273019	 273025	 273029	 273046
 273016	 273020	 273035	 273009
 273023	 273039	 273017	 273040
 273008			

## COLOP CLASSIC LINE METAL FRAME SELF-INKING DATERS

Choose Greenline for a sustainable solution made with 85% recycled plastic. For frequent and repetitive use in daily office work. Chromium-plated steel combined with durable plastic parts ensures very smooth operation, time after time! Featuring a large index window for viewing the imprint and improved ink pad technology ensures even more imprints of sharp and consistent quality. See table over for sku details.



## COLOP ROLLER STAMPS

The revolutionary pre-inked stamp on a roll! Supplied with a clip-on lid for easy storage. Allows multiple impressions with a continuous roll. Text height 7.5mm. See table over for sku details.



353050



353051



353052



353053



353054



353055



353056



353057



353058



353059



353060



353061

## COLOP DO-IT-YOURSELF PRINTER KITS

Make your own self-inking stamp. Quick to set up and easy to change. With a choice of five or six lines, you can get your message across. See table over for sku details.





## COLOP PRINTER LINE – SELF-INKING STAMPS

Multi-purpose plastic self-inking stamps for daily use. These stamps are available in the most popular colours, in an attractive and ergonomic design. The viewable template ensures these stamps are user-friendly. Thoughtful design makes changing the pads a breeze! See table over for sku details.



350005

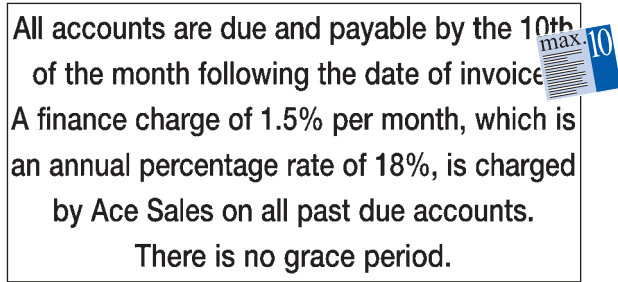

Printer 60

76 x 37mm



Printer 20

38 x 14mm



352886

353080



PRINTER Q43

43 x 43mm

## COLOP PRINTER LINE – SELF-INKING DATERS

Choose Greenline for a sustainable solution – it's made with 85% recycled plastic. See table over for sku details.



353040



353025



350140



Classic 2160

41 x 24mm

Product	Size (mm)		Extra Ink Pad	Bi-col Ink Pad	Max lines or No. of text (mm)	Date Height (mm)	Stamp Machine Handle Colour (SKU)						Spare Pad Colour (SKU)						
	Shape	w x h					Black	Blue	Dry	Green	Grey	Red	Bi-col Blu/Red	Black	Blue	Dry	Green	Red	Violet
<b>Colop Printer Line - Self-inking Stamps</b>																			
Printer 10	Rectangle	27 x 10	E/10	E10/2	3		350000								350565	350570	350575	350580	350585
Printer 15	Oblong	69 x 10	E/15		2		350135								350595	350600	350605	350615	350615
Printer 20	Rectangle	38 x 14	E/20		4		350005	350011							350625	350630	350635	350640	350645
Printer 25	Oblong	75 x 15	E/25		4														
Printer 30	Rectangle	47 x 18	E/30		5		350040	350046							350655	350660	350665	350670	350675
Printer 40	Rectangle	59 x 23	E/40		6		350075	350081							350690	350695	350700	350705	350705
Printer 45	Oblong	82 x 25	E/45		6		352872								352918		352919		
Printer 50	Rectangle	69 x 30	E/50		7		350111								350716	350721	350726	350731	350736
Printer 55	Rectangle	60 x 40	E/55		8		350125								350775	350780	350785		350795
Printer Oval 55	Oval	55 x 35	E/Oval55		6														
Printer 60	Rectangle	76 x 37	E/60		8		350116								350745	350750	350755	350760	350765
Printer Q12	Square	12 x 12	E/Q12		5		353080								353081	353083	353084		353082
Printer Q17	Square	17 x 17	E/Q17		5		352880								352950	352954	352955		
Printer Q24	Square	24 x 24	E/Q24		8		352960								352961	352963	352964		352962
Printer Q30	Square	31 x 31	E/Q30		8		352884								352966				
Printer Q43	Square	43 x 43	E/Q43		10		352886								352977	352978			352976
Greenline Printer 20	Rectangle	38 x 14	E/20		4				353000						350625	350630	350635	350640	350645
Greenline Printer 30	Rectangle	47 x 18	E/30		5				353005						350655	350660	350665	350670	350675
Greenline Printer 40	Rectangle	59 x 23	E/40		6				353010						350690	350695	350700	350705	350705
<b>Colop Do-it-Yourself Printer Kits</b>																			
Printer 30/1 D.I.Y. Set	Rectangle	47 x 18	E/30		5	Max. 21 letters per line		351236							350655	350660	350665	350670	350675
Printer 40/2 D.I.Y. Set	Rectangle	59 x 23	E/40		6	Max. 26 letters per line		351237							350690	350695	350700	350705	350705
<b>Colop Classic Line Metal Frame Selfinking Stamps</b>																			
2600	Rectangle	58 x 37	E/2600		8		350255								351110	351115	351120		351130
2800	Rectangle	68 x 49	E/2800	Dual pad incl	10		350260								351145		351155		
<b>Colop Printer Line - Self-inking Daters</b>																			
Dater Q30	Square	30 x 30	E/Q30		4		352970								352972	352973			352971
Printer R30-Dater	Round	30 diam	E/R30		3														
Printer 60-Dater	Rectangle	76 x 37	E/60		7		350121								350745	350750	350755	350760	350765
Mini-Dater S120	Dater only		E/10		4										350565	350570	350575	350580	350585
Mini-Dater S160	Oblong	25 x 5	E/10	E10/2	2										351185	350570	350575	350580	350585
Printer S260-Dater	Rectangle	45 x 24	E/200	E/200/2	4		350175								351195	350985	350990	350995	351005
Printer S260-Dater/L2 "Paid Finished"	Rectangle	45 x 24	E/200	E/200/2	4	Received/By:		350195							351195	350985	350990	350995	351005
Dater S120/WD Word Dater			E/12	E/12/2	4		351250												
Dater 60 Stamp High	Rectangle	76 x 37	E/60		16														
Band Dater 0500			E/200		5		350458												
Dater S220 Green Line			E/200		4				353025						350985	350990	350995		351005
Dater S220/W "Dial-a-Phrase" Green Line			E/200		4				353030						350985	350990	350995		351005

Product	Shape	Size (mm) w x h	Extra Ink Pad	Bi-col Ink Pad	Max lines or No. of text (mm)	Other	Stamp Machine Handle Colour (SKU)	Spare Pad Colour (SKU)
Dater S260/L1 "Received" Green Line	24 x 45	E/200	E/200/2	3	353035		350985 350990 350995	351005
Dater S260/L3 "Faxed" Green Line	24 x 45	E/200	E/200/2	3	353040		350985 350990 350995	351005
<b>Colop Classic Line Metal Frame Self-Inking Daters</b>								
2100/4-Dater	Rectangle 41 x 24	E/2100	E/2100/2	4	Blk/Red 351845		351015 351020 351035	351030
2160-Dater	Rectangle 45 x 30	E/2300	E/2300/2	5	350267	351195	351015 351020 351035	351030
2360-Dater	Rectangle 45 x 30	E/2300	E/2300/2	5	350275	351215	351040 351045 351050	351060
2360-Dater Green Line	Rectangle 45 x 30	E/2300	E/2300/2	5	353015		351040 351045 351050	351060
2660-Dater	Rectangle 58 x 37	E/2600	E/2600/2	7	Centre Date 350285	351235	351110 351115 351120	351130
2660-Dater Green Line	Rectangle 58 x 37	E/2600	E/2600/2	7	Centre Date 353020		351110 351115 351120	351130
2860-Dater	Rectangle 68 x 49	E/2800		9	350290		351145 351155	
<b>Colop Numberers</b>								
Band Numberer 04008	Band 12	na		4	Black 353085			
Band Numberer 09012	Band 6	na		9	350510			
Band Numberer 15006	Band 30 x 58	E/2600		15	350535			
Stamp Numberer 2010/P	Rectangle 27 x 10	E/200		5	353095		351110 351115 351120	351130
Stamp Numberer S226/P	Rectangle 27 x 10	E/200		4	353090		350985 350990 350995	351005
<b>Colop Roller Stamp</b>								
Roller Stamp "CANCELLED"	27 x 7.5				353050 *			
Roller Stamp "URGENT"	28 x 7.5				353051			
Roller Stamp "CONFIDENTIAL"	29 x 7.5				353052			
Roller Stamp "NOT TRANSFERABLE"	30 x 7.5				353053			
Roller Stamp "ENTERED"	31 x 7.5				353054			
Roller Stamp "COPY"	32 x 7.5				353055			
Roller Stamp "PAID"	33 x 7.5				353056			
Roller Stamp "FAXED"	34 x 7.5				353057			
Roller Stamp "RECEIVED"	35 x 7.5				353058			
Roller Stamp "COMPLETED"	36 x 7.5				353059			
Roller Stamp "PROCESSED"	37 x 7.5				353060			
Roller Stamp "DRAFT"	38 x 7.5				353061			
<b>Colop Micro Stamp Pads for Use with Traditional Hand Stamps</b>								
Micro 1 Stamp Pad	90 x 50						351275 351280 351285	351300
Micro 2 Stamp Pad	110 x 70						351305 351310 351315	351330
Micro 3 Stamp Pad	160 x 90						351335 351340 351345	351360
<b>Colop Ink Refills</b>								
Stamp Pad Ink 25ml							351390 351395	351400 351405 351410







\*Indent Only

# STAMP ORDER FORM



## STEP 1: YOUR DETAILS

Your name and address: _____      Contact: _____	Customer ID: _____	Delivery address if different: _____      Tel: _____
--	--------------------	--

## STEP 2: SELECT YOUR STAMP - FILL IN REQUIRED PRODUCT

<b>Colop Printer Line</b>  Order ID: _____ Pad colour: please tick <input checked="" type="checkbox"/> <input type="checkbox"/> <input type="checkbox"/> <input type="checkbox"/>	<b>Colop Classic Line</b>  Order ID: _____ Pad colour: please tick <input checked="" type="checkbox"/> <input type="checkbox"/> <input type="checkbox"/> <input type="checkbox"/>	<b>Colop Roller Stamp</b>  Order ID: _____
<b>Colop Mini-dater</b>  Order ID: _____ Pad colour: please tick <input checked="" type="checkbox"/> <input type="checkbox"/> <input type="checkbox"/> <input type="checkbox"/>	<b>Colop Band Stamps</b>  Order ID: _____ Pad colour: please tick <input checked="" type="checkbox"/> <input type="checkbox"/> <input type="checkbox"/> <input type="checkbox"/>	<b>Colop Spare Pads</b>  Order ID: _____ Pad colour: please tick <input checked="" type="checkbox"/> <input type="checkbox"/> <input type="checkbox"/> <input type="checkbox"/>

## STEP 3: DESIGN YOUR IMPRINT

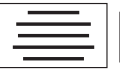
<b>Styles</b> please tick <input checked="" type="checkbox"/>	<b>Text Style</b> please tick <input checked="" type="checkbox"/>	please tick <input checked="" type="checkbox"/>
with Border <input type="checkbox"/> 	Regular <input type="checkbox"/>	ALL CAPITALS <input type="checkbox"/>
Flush left <input type="checkbox"/> 	Bold <input type="checkbox"/>	Capitals and Lower Case <input type="checkbox"/>
Flush right <input type="checkbox"/> 	Italic <input type="checkbox"/>	
Centred <input type="checkbox"/> 		

## STEP 4: WORDING REQUIRED

<b>Stamp Details and Diagram Area</b> (Block capitals, pay attention to maximum number of lines) 1 _____ 2 _____ 3 _____ 4 _____ 5 _____ 6 _____ 7 _____ 8 _____ 9 _____ 10 _____	<b>Special Instructions</b>          Please fax/email to: _____
---	---

## STEP 5: CUSTOMER SIGNATURE AND DATE

--	--

Photocopy this form for future use!